

S O U N D P R O J E C T S

PRODUCT INFORMATION

Σ -SERIES

LINE ARRAY SYSTEMS



SOUND PROJECTS
Jonkerweg 17-19
1217 PM Hilversum
The Netherlands
Phone +31 (0)35 6213233
Fax +31 (0)35 6215455

Σ-SERIES

The SOUND PROJECTS Σ-series (Sigma series) is a line of loudspeakers that fully incorporate the principals of vertical line arrays. Advanced engineering has resulted in optimised line array performance with consistent, reliable coverage. All cabinets within the Σ-series feature SOUND PROJECTS proprietary Wave-shape-transformer™, Σasy-rig™ flying hardware, and work with most other SOUND PROJECTS loudspeakers.

All cabinets within the Σ-series are shaped trapezoidal, enabling curvilinear arrays without openings between cabinets fronts.

The SP10-Σ and SP20-Σ enclosures have the same width, but differ in loudness and horizontal coverage, making it ideal to combine in single, aesthetically matching, ultra slim arrays. Although the SP30-Σ is double the width of the SP10-Σ and SP20-Σ, the enclosures can easily be combined by means of an adapting flying frame.

The SP30-Σ Line Array loudspeaker is a high power, long-throw system for large scale sound reinforcement. Featuring SOUND PROJECTS patented Wave-shape-transforming™ technology, the SP30-Σ combines real power and convincing, consistent directional control. An SP4-15 extends the system response to 25 Hz and can be adapted to be flown in the same array as the SP30-Σ.

The SP20-Σ Compact Line Array loudspeaker provides exceptionally consistent sound quality combined with impressive power in a very compact housing. Intended for medium to large-scale applications it is capable of generating high output yet able to cover a reasonable vertical area with only a few cabinets.

The SP10-Σ Ultra Compact Line Array loudspeaker basically is half an SP20-Σ but with a slightly larger horizontal coverage. Ideal for small to medium venues where large horizontal coverage is needed, as centre-cluster or down-fill at an array of SP20-Σ's.



WAVE-SHAPE-TURNFORMER™ TECHNOLOGY

The unique and patented High Frequency Wave-shape-transformer™ is the vital backbone of all Sound Projects Σ -series Line Array models. This unique, proprietary acoustic wave-guiding technology transforms the spherical uni-phase wave-front generated by the HF compression driver to a near perfect cylindrical wave-front emerging from the front of the array. Smooth, tightly controlled horizontal, and even more important, vertical dispersion present the necessary virtual "slice of audio" that easily can be stacked on top of each other. The combined result surpasses the sum of the parts: real power and convincing, consistent directional control.

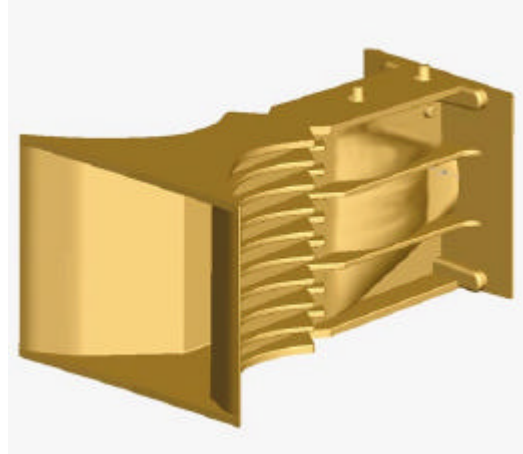

THE SP30- Σ LOUDSPEAKER

SP30- Σ loudspeaker

Because of the trapezoidal shape of the enclosure angles up to 8 degrees between cabinets can be established with closed cabinet fronts. The SP30- Σ incorporates a total of three Wave-shape-transformers™ adapted for 3"-diaphragm high frequency drivers. The four slightly tilted 8" neodymium drivers are positioned behind the Wave-shape-transformer™ to acquire wide horizontal dispersion in the mid frequencies. The two 15-inch drivers at the front of the cabinet take care of the low frequencies. Unlike most other major line array systems the SP30- Σ incorporates two extra side-firing 15-inches to provide the sub-low frequencies. The integrated heavy duty flying hardware is designed to hold up to 24 cabinets with a safety factor 10.



THE SP20-Σ LOUDSPEAKER

SP20-Σ loudspeaker

Preliminary measurement data under non-anechoic conditions.

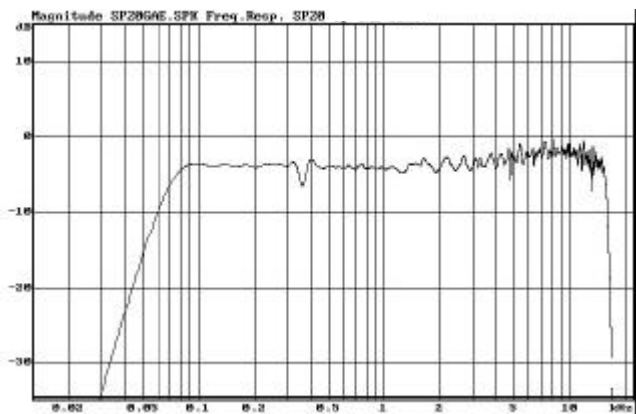

Vertical 2D Directivity Plot SP20-Σ

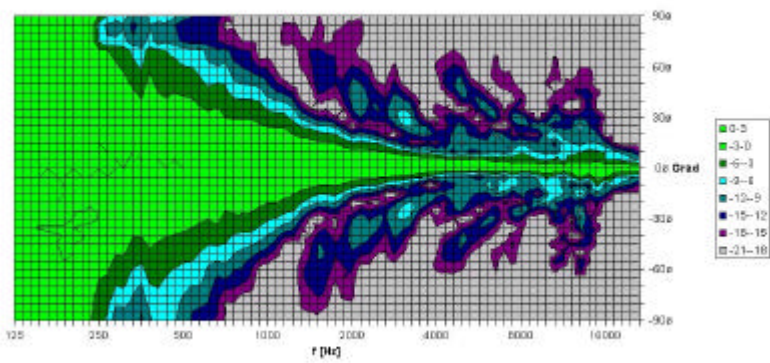
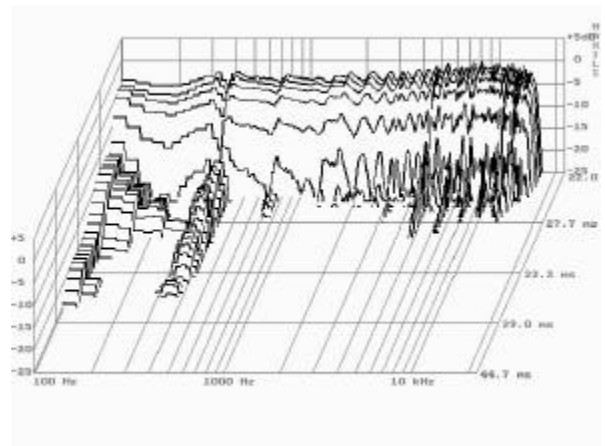

Horizontal 2D Directivity Plot SP20-Σ

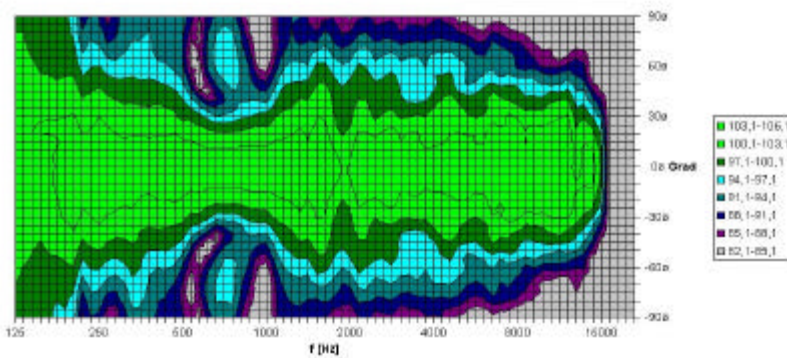

THE SP10-Σ LOUDSPEAKER

SP10-Σ loudspeaker

Preliminary measurement data under non-anechoic conditions.

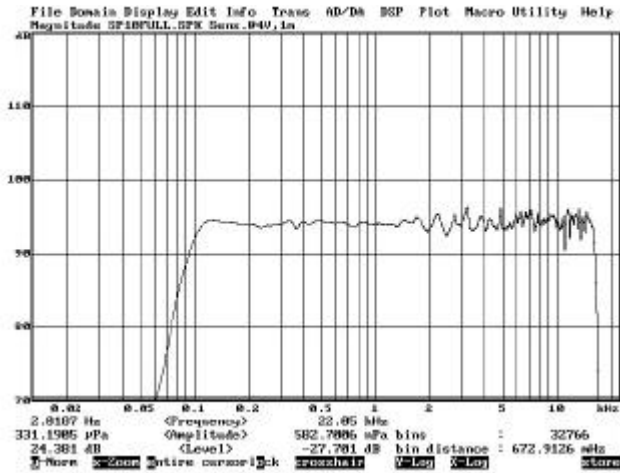

Vertical 2D Directivity Plot SP10-Σ

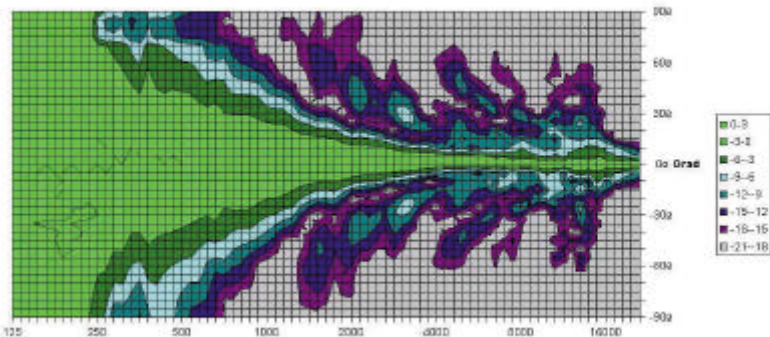
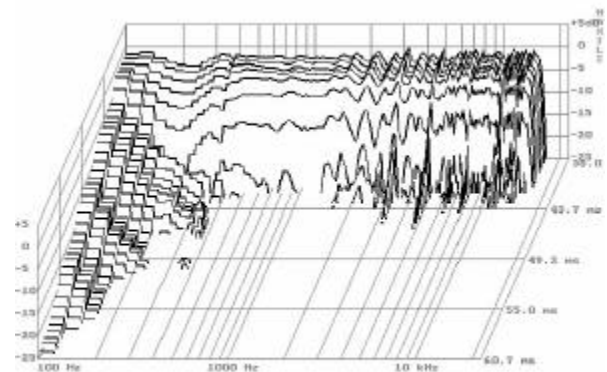

Horizontal 2D Directivity Plot SP10-Σ

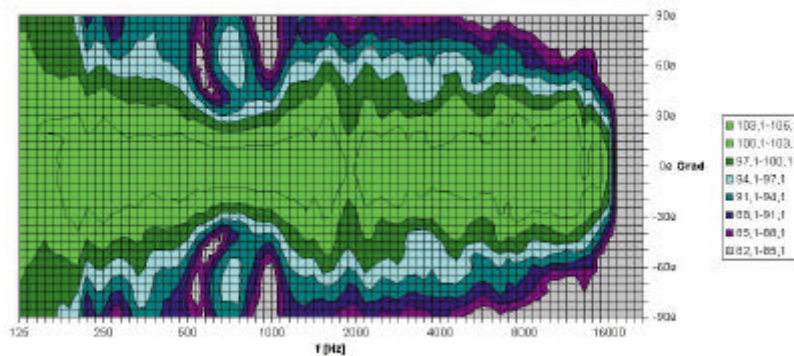

TECHNICAL SPECIFICATIONS

Technical specifications for Sigma series cabinets			
System	SP30- Σ	SP20- Σ	SP10- Σ
Horizontal coverage	90°	90°	90°
Vertical coverage	Defined by the array length and shape		
LF1 Power Handling*	1200W	600W	-
LF2 Power Handling*	1200W	600W	300W
MB Power Handling*	1200W	600W	300W
HF Power Handling*	600W	300W	150W
Sensitivity (LF/MF/HF)	(105/111/115)	(103/103/109)	(93/100/106)
Max Calculated SPL	140 dB	133 dB	125 dB
LF1 Transducer (pin 1)	2 x 15"	12"	4 x 5"
LF2 Transducer (pin 2)	2 x 15"	12"	-
MF Transducer (pin 3)	4 x 8"	4 x 6.5"	2 x 6.5"
HF Transducer (pin 4)	3 x 3" Diaphragm	2 x 2" Diaphragm**	1 x 2" Diaphragm**
Connectors (other on request)	2 x Neutrik NL8 daisy chained pin 1 – LF1 @ 8 Ω pin 2 – LF2 @ 8 Ω pin 3 – MB @ 8 Ω pin 4 – HF @ 24 Ω	-2 x Neutrik NL8 daisy chained pin 1 – LF1 @ 8 Ω pin 2 – LF2 @ 8 Ω pin 3 – MB @ 8 Ω pin 4 – HF @ 8 Ω	-2 x Neutrik NL8 – daisy chained pin 1 – pin 2 – LF @ 16 Ω pin 3 – MB @ 16 Ω pin 4 – HF @ 16 Ω
Enclosure Material	Polymer coated multi-layer cross grain Plywood		
Grille	Powder coated Steel grill with Acoustically-transparent foam		
IP rating	IP 24	IP 24	IP 24
Dimensions (WxHxD)	1200 x 490 x 800	580x 340 x 540	580 x 170 x 540
Net weight	120kg	34kg	20kg

Technical Specifications for Four-cabinet FLAT array			
System	4 x SP 30- Σ	4 x SP 20- Σ	4 x SP 10- Σ
Frequency response	50Hz - 18 kHz	65Hz – 18 kHz	65Hz – 18 kHz
Max Calculated SPL	152 dB	145 dB	137 dB
Horizontal Coverage	90°	90°	90°
Vertical Coverage			

Technical Specifications for Four-cabinet CURVED array			
System	4 x SP 30- Σ	4 x SP 20- Σ	4 x SP 10- Σ
Frequency response	50Hz - 18 kHz	65Hz – 18 kHz	65Hz – 18 kHz
Max Calculated SPL (1W / 1m)	149 dB	142 dB	134 dB
Horizontal Coverage	90°	90°	90°
Vertical Coverage	max. 32°	max. 20°	max. 20°

* at rated impedance

** 3" Diaphragm optional

ΣASY-RIG™ FLYING HARDWARE

The Σ-series enclosures come with Σasy-rig™ cabinet hardware integrated in the cabinet design. The Σasy-rig™ flying system provides numerous rigging possibilities.

The proprietary flying system for SP10-Σ and SP20-Σ can hold up to 860 kg (48 SP10-Σ cabinets or up to 24 SP20-Σ in a column), with a safety factor of 10. When used as a single column array the truss-module is accommodated with a 5T shackle to provide connection with lifting gear. Positioning the shackle to the back of the truss-module will slant the array to the front.



Σasy-rig™ flying hardware with SP10-Σ cabinets.